

Charging Circuit

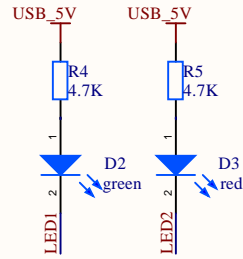

Charging Indicator

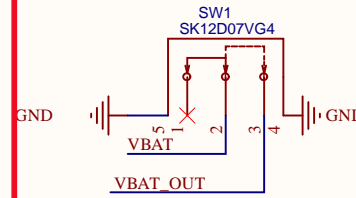

Mains Switch

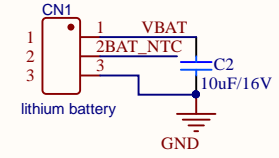

Lithium Battery Interface

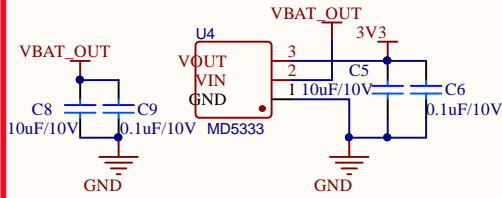

LDO Voltage Regulator

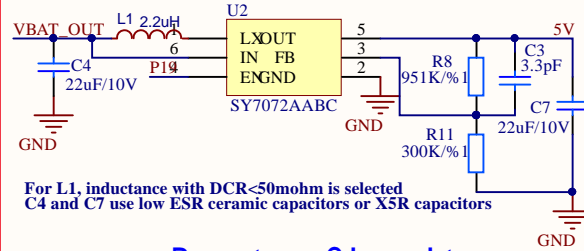

For L1, inductance with DCR<50mohm is selected
C4 and C7 use low ESR ceramic capacitors or X5R capacitors

Booster Circuit

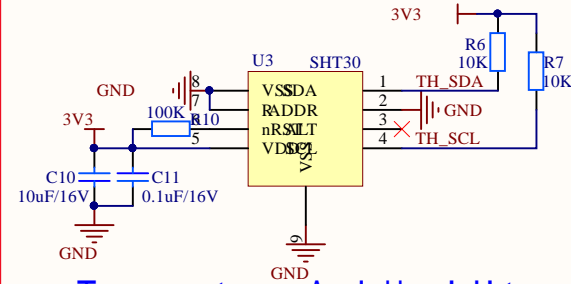

Temperature And Humidity

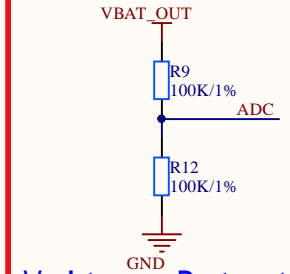

Voltage Detection

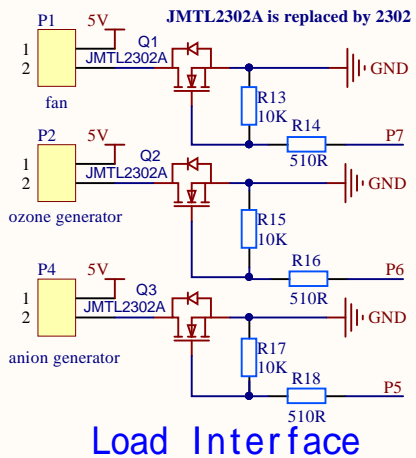

Load Interface

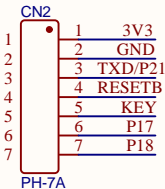

Indicator Port
Key And Reset Key Interface

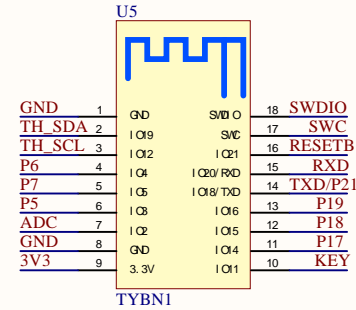

Bluetooth Module

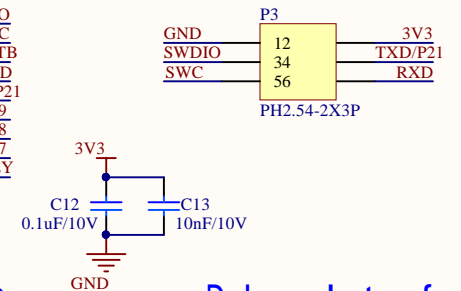

Debug Interface

Title		
Size	Number	Revision
A4		
Date:	2021/10/14	Sheet of
File:	F:\工作资料\智能除味器主控板-奥	DocNo: