



Application Note: SY8121B

High Efficiency Fast Response, 2A, 18V Input 1.2MHz Synchronous Step Down Regulator

General Description

SY8121B develops high efficiency synchronous step-down DC-DC converter capable of delivering 2A load current. SY8121B operates over a wide input voltage range from 4.35V to 18V and integrates main switch and synchronous switch with very low $R_{DS(ON)}$ to minimize the conduction loss.

SY8121B always operates under continuous condition mode, low output ripple and small inductor and capacitor size are achieved with 1.2MHz switching frequency.

Ordering Information

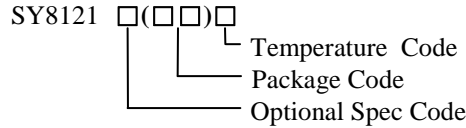

Ordering Number	Package type	Note
SY8121BABC	SOT23-6	--

Features

- Low $R_{DS(ON)}$ for internal switches (top/bottom):170/160 mΩ
- 4.35-18V input voltage range
- 2A load current capability
- Instant PWM architecture to achieve fast transient responses
- Internal softstart limits the inrush current
- 2% 0.6V reference
- RoHS Compliant and Halogen Free
- Compact package: SOT23-6

Applications

- Set Top Box
- Portable TV
- Access Point Router
- DSL Modem
- LCD TV

Typical Applications

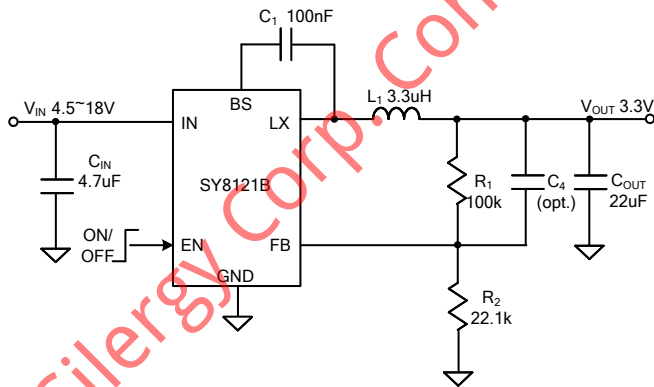

Figure 1. Schematic Diagram

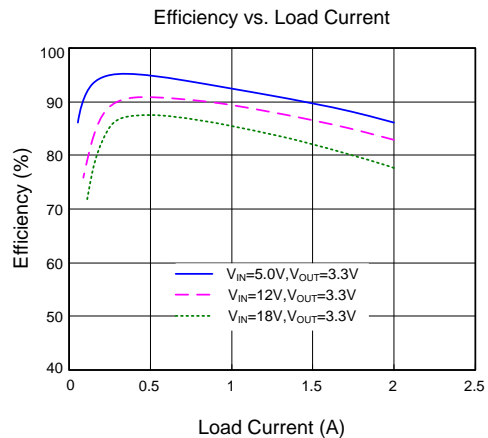
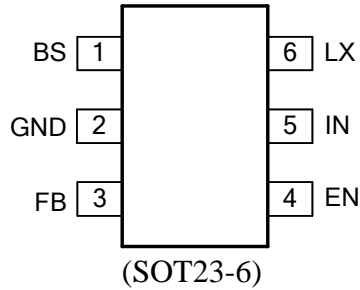

Figure 2. Efficiency Figure

Pinout (top view)



Top Mark: TVxyz for SY8121BABC, (Device code: TV, *x*=year code, *y*=week code, *z*=lot number code)

Pin Name	SOT23-6	Pin Description
BS	1	Boot-Strap Pin. Supply high side gate driver. Decouple this pin to LX pin with 0.1uF ceramic cap.
GND	2	Ground pin
FB	3	Output Feedback Pin. Connect this pin to the center point of the output resistor divider (as shown in Figure 1) to program the output voltage: $V_{OUT}=0.6*(1+R1/R2)$
EN	4	Enable control. Pull high to turn on. Do not float.
IN	5	Input pin. Decouple this pin to GND pin with at least 1uF ceramic cap
LX	6	Inductor pin. Connect this pin to the switching node of inductor

Absolute Maximum Ratings (Note 1)

Supply Input Voltage	21V
LX, EN Voltage	$V_{IN} + 0.3V$
FB, BS-LX Voltage	4V
Power Dissipation, P_D @ $T_A = 25^\circ C$ SOT23-6,	1W
Package Thermal Resistance (Note 2)	
θ_{JA}	100 $^\circ C/W$
θ_{JC}	25 $^\circ C/W$
Junction Temperature Range	150 $^\circ C$
Lead Temperature (Soldering, 10 sec.)	260 $^\circ C$
Storage Temperature Range	-65 $^\circ C$ to 150 $^\circ C$
Dynamic LX Voltage in 10ns duration	-IN+3V to GND-5V

Recommended Operating Conditions (Note 3)

Supply Input Voltage	4.35V to 18V
Junction Temperature Range	-40 $^\circ C$ to 125 $^\circ C$
Ambient Temperature Range	-40 $^\circ C$ to 85 $^\circ C$

Block Diagram

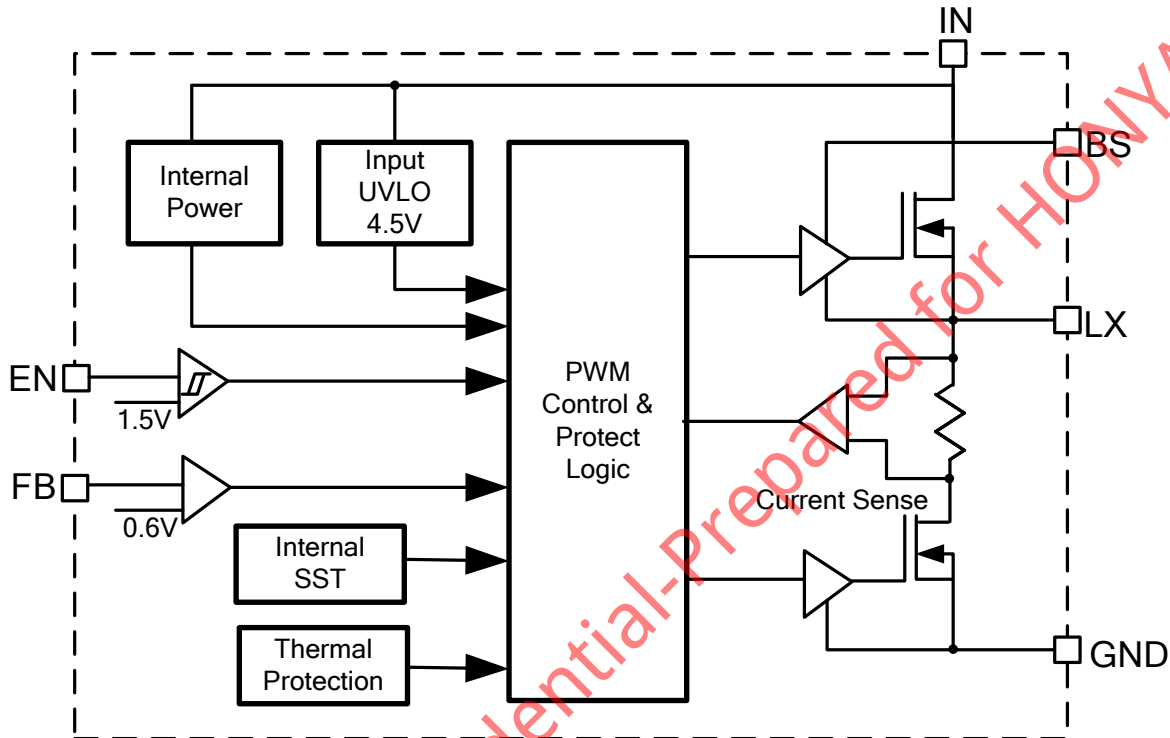

Silergy Corp. Confidential-Prepared for HONYAR

Electrical Characteristics

($V_{IN} = 12V$, $V_{OUT} = 1.2V$, $L = 2.2\mu H$, $C_{OUT} = 10\mu F$, $T_A = 25^\circ C$, $I_{OUT} = 1A$ unless otherwise specified)

Parameter	Symbol	Test Conditions	Min	Typ	Max	Unit
Input Voltage Range	V_{IN}		4.35		18	V
Shutdown Current	I_{SHDN}	EN=0		5	10	μA
Feedback Reference Voltage	V_{REF}		0.588	0.6	0.612	V
FB Input Current	I_{FB}	$V_{FB} = V_{IN}$	-50		50	nA
Top FET RON	$R_{DS(ON)1}$			0.17		Ω
Bottom FET RON	$R_{DS(ON)2}$			0.16		Ω
Bottom FET Valley Current Limit	I_{LIM}		2	2.7	3.45	A
EN Rising Threshold	V_{ENH}		1.5			V
EN Falling Threshold	V_{ENL}				0.4	V
Input UVLO Threshold	V_{UVLO}				4.35	V
Switching Frequency	F_{SW}			1.2		MHz
Min ON Time				50		ns
Min Off Time				100		ns
Thermal Shutdown Temperature	T_{SD}			150		$^\circ C$
Thermal Shutdown Hysteresis	T_{HYS}			15		$^\circ C$

Note 1: Stresses beyond “Absolute Maximum Ratings” may cause permanent damage to the device. These are for stress ratings. Functional operation of the device at these or any other conditions beyond those indicated in the operational sections of the specifications is not implied. Exposure to absolute maximum rating conditions may affect device reliability.

Note 2: θ_{JA} is measured in the natural convection at $T_A = 25^\circ C$ on a high effective thermal conductivity four-layer test board per JEDEC 51-7. Pin 2 of SOT-23-6 package is the case position for θ_{JC} measurement.

Note 3: The device is not guaranteed to function outside its operating conditions.

Typical Performance Characteristics

Efficiency vs. Load Current

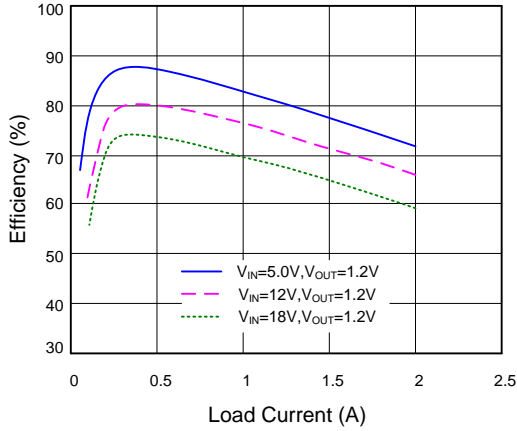

Efficiency vs. Load Current

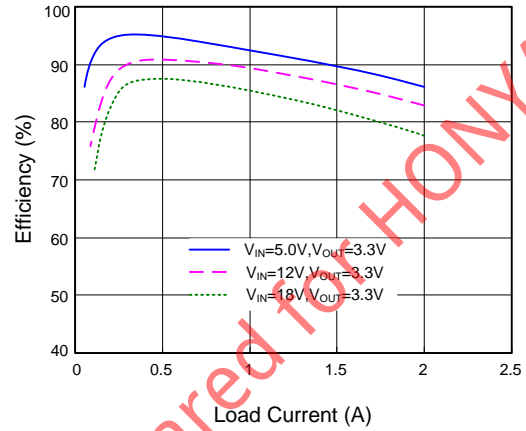

Efficiency vs. Load Current

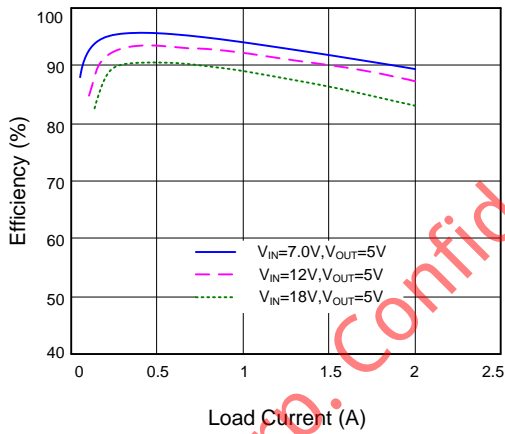

Output Ripple

($V_{IN}=12V, V_{OUT}=3.3V, I_{LOAD}=2A$)

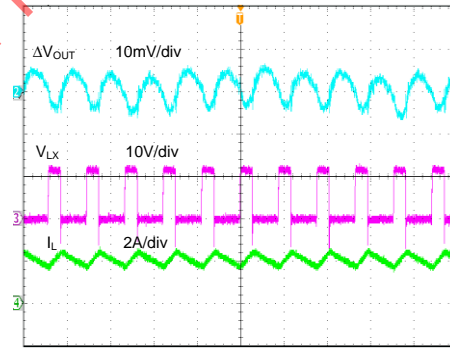

Load Transient

($V_{IN}=12V, V_{OUT}=3.3V, I_{LOAD}=Null \sim 1A$)

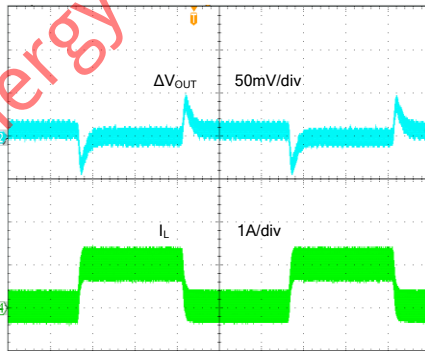

Load Transient

($V_{IN}=12V, V_{OUT}=3.3V, I_{LOAD}=0.2 \sim 2A$)

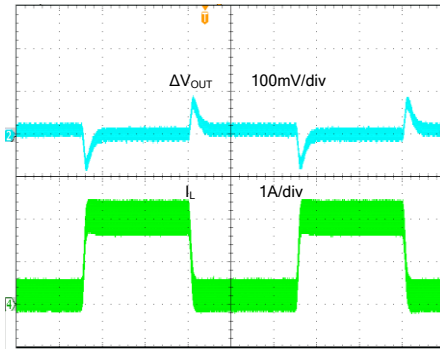

Startup from V_{IN}
($V_{IN}=12V$, $V_{OUT}=3.3V$, $I_{LOAD}=2A$)

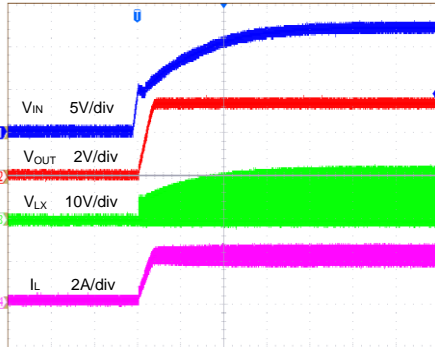

Time (2ms/div)

Shutdown from V_{IN}
($V_{IN}=12V$, $V_{OUT}=3.3V$, $I_{LOAD}=2A$)

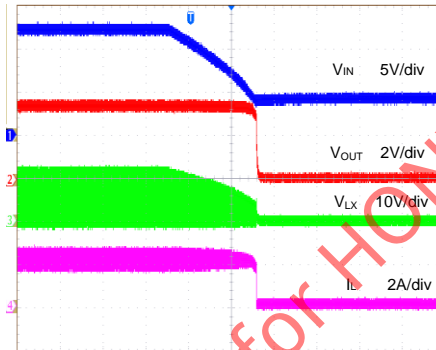

Time (2ms/div)

Startup from Enable
($V_{IN}=12V$, $V_{OUT}=3.3V$, $I_{LOAD}=2A$)

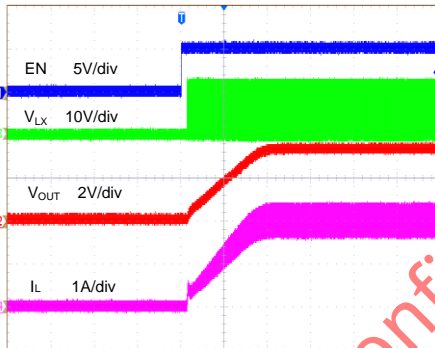

Time (400 μ s/div)

Shutdown from Enable
($V_{IN}=12V$, $V_{OUT}=3.3V$, $I_{LOAD}=2A$)

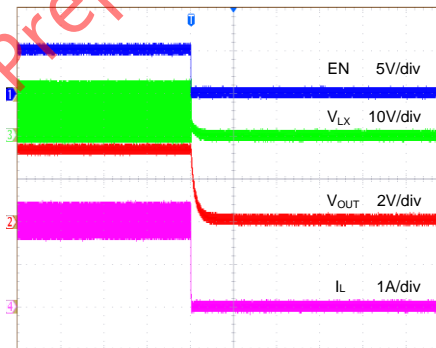

Time (400 μ s/div)

Hard Short Protection
($V_{IN}=12V$, $V_{OUT}=3.3V$, 2A to Short)

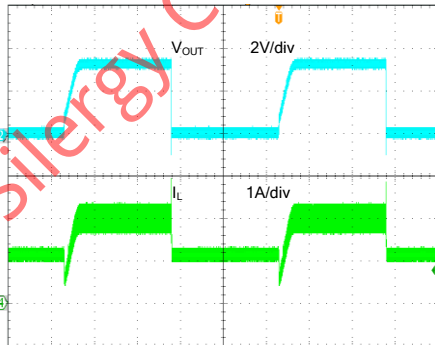

Time (2ms/div)

Hard Short Protection
($V_{IN}=12V$, $V_{OUT}=3.3V$, Null Load to Short)

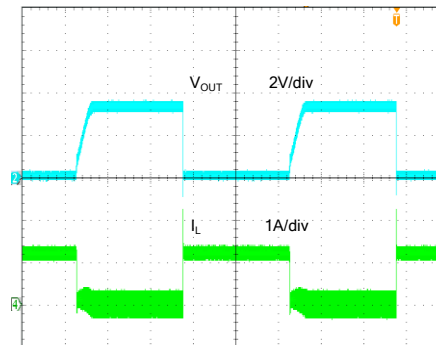

Time (2ms/div)

Operation

SY8121B is a synchronous buck regulator IC that integrates the PWM control, top and bottom switches on the same die to minimize the switching loss and conduction loss. With ultra low $R_{DS(ON)}$ power switches and proprietary PWM control, this regulator IC can achieve high efficiency and fast transient response. High switch frequency minimizes the external inductor and capacitor size, and thus achieving the minimum solution footprint.

SY8121B also features cycle by cycle current limiting, output short circuit protection and thermal shutdown protection.

Applications Information

Because of the high integration in the SY8121B IC, the application circuit based on this regulator IC is rather simple. Only input capacitor C_{IN} , output capacitor C_{OUT} , output inductor L and feedback resistors (R_1 and R_2) need to be selected for the targeted applications specifications.

Feedback resistor dividers R_1 and R_2 :

Choose R_1 and R_2 to program the proper output voltage. To minimize the power consumption under light loads, it is desirable to choose large resistance values for both R_1 and R_2 . A value of between $10k\Omega$ and $1M\Omega$ is highly recommended for both resistors. If V_{out} is 3.3V, $R_1=100k$ is chosen, then using following equation, R_2 can be calculated to be 22.1k:

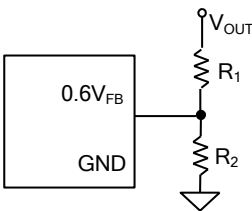
$$R_2 = \frac{0.6V}{V_{OUT} - 0.6V} R_1$$

Input capacitor C_{IN} :

The ripple current through input capacitor is calculated as:

$$I_{CIN_RMS} = I_{OUT} \cdot \sqrt{D(1-D)}$$

To minimize the potential noise problem, place a typical X5R or better grade ceramic capacitor really close to the IN and GND pins. Care should be taken to minimize the loop area formed by C_{IN} , and IN/GND pins. In this case, a 4.7uF low ESR ceramic capacitor is recommended.

Output capacitor C_{OUT} :

The output capacitor is selected to handle the output ripple noise requirements. Both steady state ripple and transient requirements must be taken into consideration when selecting this capacitor. For the best performance, it is recommended to use X5R or better grade ceramic capacitor greater than 22uF capacitance.

Output inductor L :

There are several considerations in choosing this inductor.

- 1) Choose the inductance to provide the desired ripple current. It is suggested to choose the ripple current to be about 40% of the maximum output current. The inductance is calculated as:

$$L = \frac{V_{OUT}(1 - V_{OUT}/V_{IN,MAX})}{F_{SW} \times I_{OUT,MAX} \times 40\%}$$

where F_{sw} is the switching frequency and $I_{OUT,MAX}$ is the maximum load current.

The SY8121B regulator IC is quite tolerant of different ripple current amplitude. Consequently, the final choice of inductance can be slightly off the calculation value without significantly impacting the performance.

- 2) The saturation current rating of the inductor must be selected to be greater than the peak inductor current under full load conditions.

$$I_{SAT, MIN} > I_{OUT, MAX} + \frac{V_{OUT}(1 - V_{OUT}/V_{IN,MAX})}{2 \cdot F_{SW} \cdot L}$$

- 3) The DCR of the inductor and the core loss at the switching frequency must be low enough to achieve the desired efficiency requirement. It is desirable to choose an inductor with $DCR < 50m\Omega$ to achieve a good overall efficiency.

External Bootstrap Cap

This capacitor provides the gate driver voltage for internal high side MOSEFET. A 100nF low ESR

ceramic capacitor connected between BS pin and LX pin is recommended.

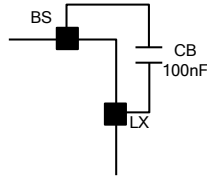

Load Transient Considerations:

The SY8121B regulator IC integrates the compensation components to achieve good stability and fast transient responses. In some applications, adding a 22pF ceramic cap in parallel with R1 may further speed up the load transient responses and is thus recommended for applications with large load transient step requirements.

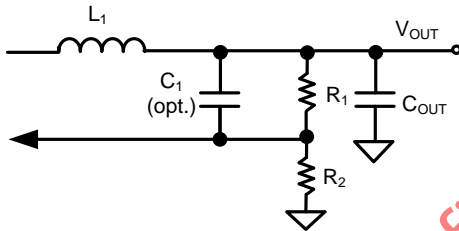

Layout Design:

The layout design of SY8121B regulator is relatively simple. For the best efficiency and minimum noise problem, we should place the following components close to the IC: C_{IN}, L, R₁ and R₂.

- 1) It is desirable to maximize the PCB copper area connecting to GND pin to achieve the best thermal and noise performance. If the board space allowed, a ground plane is highly desirable.
- 2) C_{IN} must be close to Pins IN and GND. The loop area formed by C_{IN} and GND must be minimized.
- 3) The PCB copper area associated with LX pin must be minimized to avoid the potential noise problem.
- 4) The components R₁ and R₂, and the trace connecting to the FB pin must NOT be adjacent to the LX net on the PCB layout to avoid the noise problem.
- 5) If the system chip interfacing with the EN pin has a high impedance state at shutdown mode and the IN pin is connected directly to a power source such as a Li-Ion battery, it is desirable to add a pull down 1Mohm resistor between the EN and GND pins to prevent the noise from falsely turning on the regulator at shutdown mode.

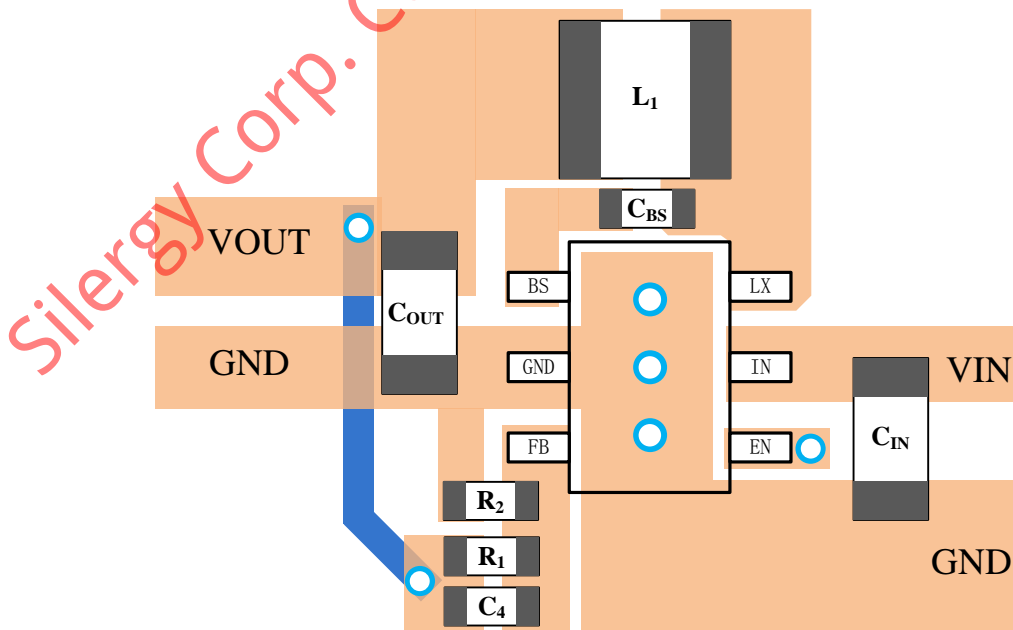

SOT23-6 Package Outline & PCB layout

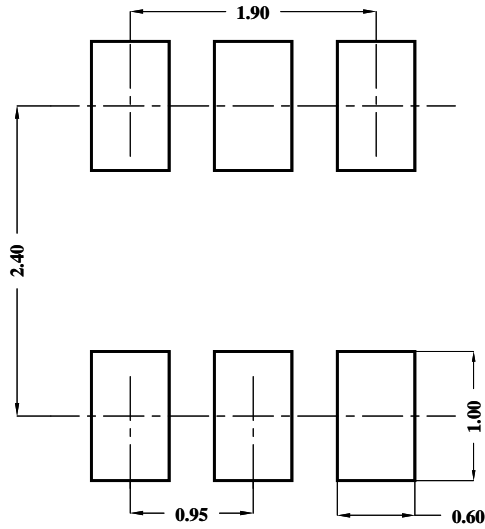

Recommended Pad Layout

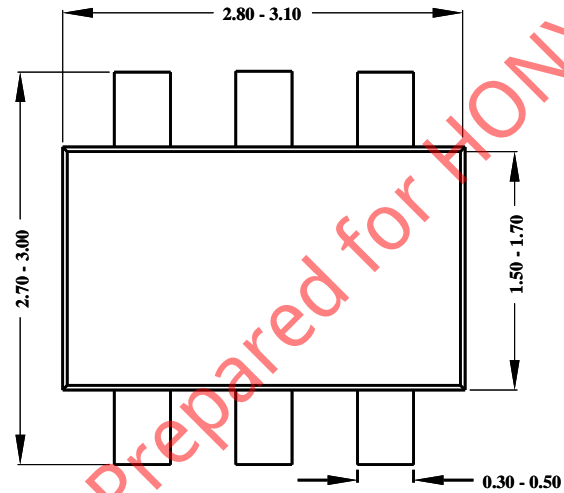

Top View

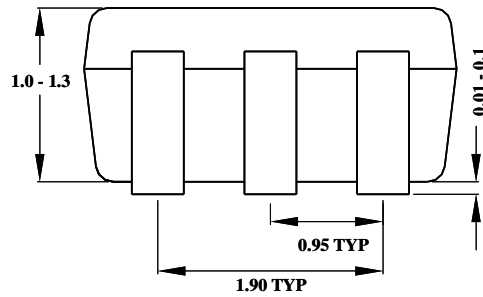
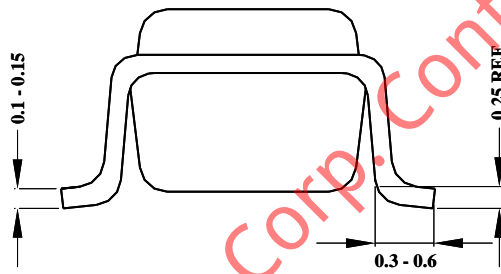

Notes: All dimension in MM
 All dimension don't include mold flash & metal burr

Taping & Reel Specification

1. SOT23-6 taping orientation

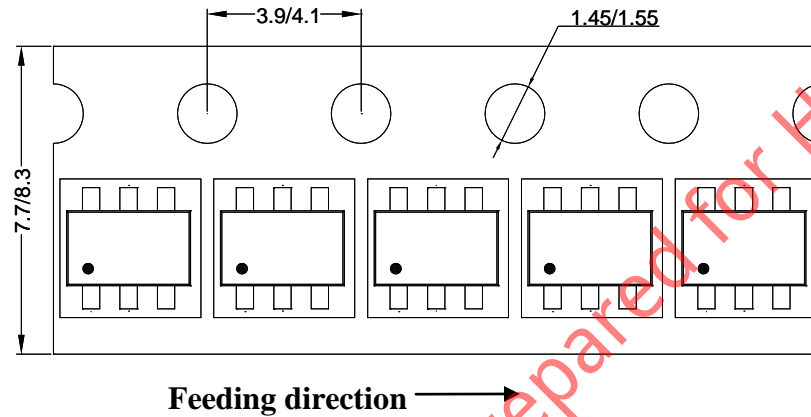

2. Carrier Tape & Reel specification for packages

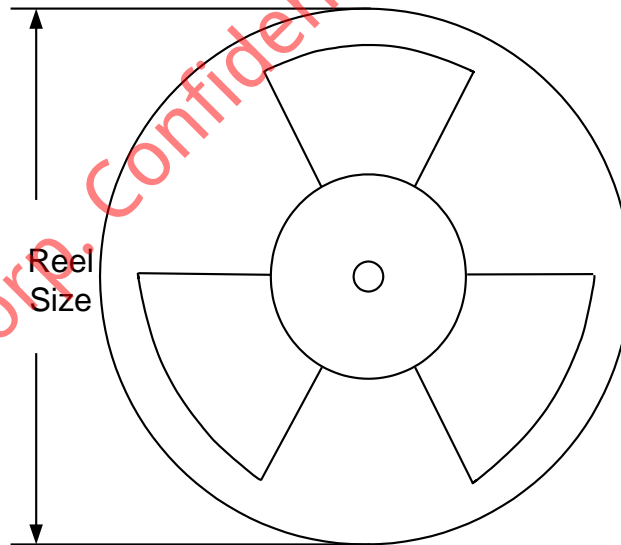

Package types	Tape width (mm)	Pocket pitch(mm)	Reel size (Inch)	Trailer length(mm)	Leader length (mm)	Qty per reel
SOT23-6	8	4	7"	280	160	3000

3. Others: NA



IMPORTANT NOTICE

- 1. Right to make changes.** Silergy and its subsidiaries (hereafter Silergy) reserve the right to change any information published in this document, including but not limited to circuitry, specification and/or product design, manufacturing or descriptions, at any time and without notice. This document supersedes and replaces all information supplied prior to the publication hereof. Buyers should obtain the latest relevant information before placing orders and should verify that such information is current and complete. All semiconductor products are sold subject to Silergy's standard terms and conditions of sale.
- 2. Applications.** Application examples that are described herein for any of these products are for illustrative purposes only. Silergy makes no representation or warranty that such applications will be suitable for the specified use without further testing or modification. Buyers are responsible for the design and operation of their applications and products using Silergy products. Silergy or its subsidiaries assume no liability for any application assistance or designs of customer products. It is customer's sole responsibility to determine whether the Silergy product is suitable and fit for the customer's applications and products planned. To minimize the risks associated with customer's products and applications, customer should provide adequate design and operating safeguards. Customer represents and agrees that it has all the necessary expertise to create and implement safeguards which anticipate dangerous consequences of failures, monitor failures and their consequences, lessen the likelihood of failures that might cause harm and take appropriate remedial actions. Silergy assumes no liability related to any default, damage, costs or problem in the customer's applications or products, or the application or use by customer's third-party buyers. Customer will fully indemnify Silergy, its subsidiaries, and their representatives against any damages arising out of the use of any Silergy components in safety-critical applications. It is also buyers' sole responsibility to warrant and guarantee that any intellectual property rights of a third party are not infringed upon when integrating Silergy products into any application. Silergy assumes no responsibility for any said applications or for any use of any circuitry other than circuitry entirely embodied in a Silergy product.
- 3. Limited warranty and liability.** Information furnished by Silergy in this document is believed to be accurate and reliable. However, Silergy makes no representation or warranty, expressed or implied, as to the accuracy or completeness of such information and shall have no liability for the consequences of use of such information. In no event shall Silergy be liable for any indirect, incidental, punitive, special or consequential damages, including but not limited to lost profits, lost savings, business interruption, costs related to the removal or replacement of any products or rework charges, whether or not such damages are based on tort or negligence, warranty, breach of contract or any other legal theory. Notwithstanding any damages that customer might incur for any reason whatsoever, Silergy' aggregate and cumulative liability towards customer for the products described herein shall be limited in accordance with the Standard Terms and Conditions of Sale of Silergy.
- 4. Suitability for use.** Customer acknowledges and agrees that it is solely responsible for compliance with all legal, regulatory and safety-related requirements concerning its products, and any use of Silergy components in its applications, notwithstanding any applications-related information or support that may be provided by Silergy. Silergy products are not designed, authorized or warranted to be suitable for use in life support, life-critical or safety-critical systems or equipment, nor in applications where failure or malfunction of an Silergy product can reasonably be expected to result in personal injury, death or severe property or environmental damage. Silergy assumes no liability for inclusion and/or use of Silergy products in such equipment or applications and therefore such inclusion and/or use is at the customer's own risk.
- 5. Terms and conditions of commercial sale.** Silergy products are sold subject to the standard terms and conditions of commercial sale, as published at <http://www.silergy.com/stdterms>, unless otherwise agreed in a valid written individual agreement specifically agreed to in writing by an authorized officer of Silergy. In case an individual agreement is concluded only the terms and conditions of the respective agreement shall apply. Silergy hereby expressly objects to and denies the application of any customer's general terms and conditions with regard to the purchase of Silergy products by the customer.
- 6. No offer to sell or license.** Nothing in this document may be interpreted or construed as an offer to sell products that is open for acceptance or the grant, conveyance or implication of any license under any copyrights, patents or other industrial or intellectual property rights. Silergy makes no representation or warranty that any license, either express or implied, is granted under any patent right, copyright, mask work right, or other intellectual property right. Information published by Silergy regarding third-party products or services does not constitute a license to use such products or services or a warranty or endorsement thereof. Use of such information may require a license from a third party under the patents or other intellectual property of the third party, or a license from Silergy under the patents or other intellectual property of Silergy.

For more information, please visit: www.silergy.com

© 2018 Silergy Corp.

All Rights Reserved.