

Standalone Linear Li-Ion Battery Charger with Thermal Regulation

■ General Description

The XT4045 is a complete constant-current /constant-voltage linear charger for single cell lithium-ion batteries. Its ThinSOT package and low external component count make the XT4045 ideally suited for portable applications. Furthermore, the XT4045 is specifically designed to work within USB power specifications.

No external sense resistor is needed, and no blocking diode is required due to the internal MOSFET architecture. Thermal feedback regulates the charge current to limit the die temperature during high power operation or high ambient temperature. The charge voltage is fixed at 4.15V, and the charge current can be programmed externally with a single resistor. The XT4045 automatically terminates the charge cycle when the charge current drops to 1/10th the programmed value after the final float voltage is reached. When the input supply (wall adapter or USB supply) is removed, the XT4045 automatically enters a low current state, dropping the battery drain current to less than 1µA. The XT4045 can be put into shutdown mode, reducing the supply current to 40µA.

When battery reversed, the internal protected the BAT pin throughout about 0.7mA current from GND.

Other features include charge current monitor, under-voltage lockout, automatic recharge and a status pin to indicate charge termination and the presence of an input voltage.

■ Features

- Programmable Charge Current Up to 500mA
- No MOSFET, Sense Resistor or Blocking Diode Required
- Complete Linear Charger in ThinSOT Package for single Cell Lithium-Ion Batteries
- Constant-Current/Constant-Voltage Operation with Thermal Regulation to Maximize Charge Rate Without Risk of Overheating
- Charges Single Cell Li-Ion Batteries Directly from USB Port
- Preset 4.15V Charge Voltage with ±50mV Accuracy
- Charge Current Monitor Output for Gas Gauging
- Automatic Recharge
- Charge Status Output Pin
- C/10 Charge Termination
- 40µA Supply Current in Shutdown
- 2.8V Trickle Charge Threshold
- Soft-Start Limits Inrush Current
- Battery reversed protection
- Available in 5-Lead SOT-23 and SOT89 Package

■ Applications

- Cellular Telephones, PDAs, MP3 Players
- Charging Docks and Cradles
- Bluetooth Applications

■ Package

- SOT-23-5L
- SOT89-5L

■ Typical Application Circuit

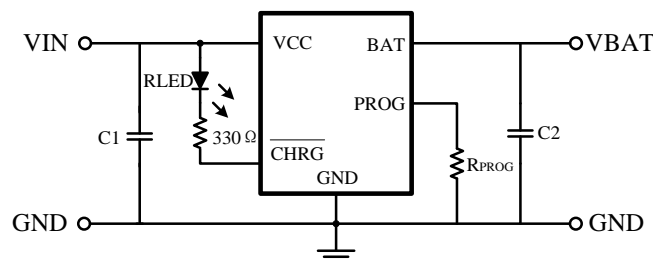

NOTE: C1=4.7µf, C2=10µF, IBAT = (V_{PROG}/R_{PROG})*1000

■ Ordering Information

XT4045 ①②③④⑤⑥-⑦

Designator	Description	Symbol	Description
①	Type	K	CHRG pin with trickle charge
②③	The regulator Output Voltage	4B	4.15
④	Accuracy of Output Voltage	5	±50mV
⑤	Packaging Types	M	SOT-23-5L
		P	SOT89-5L
⑥	Device Orientation	R	Embossed tape: Standard feed
		L	Embossed tape: Reverse feed
⑦	Material Character	G	Hologen free

■ Pin Configuration

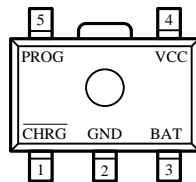

SOT-89-5L
(TOP VIEW)

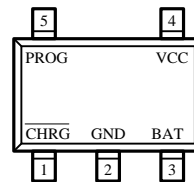

SOT-23-5L
(TOP VIEW)

■ Pin Assignment

Pin Number		Pin Name
SOT-23-5L	SOT-89-5	
1	1	CHRG
2	2	GND
3	3	BAT
4	4	VCC
5	5	PROG

■ Pin Function

CHRG (Pin 1): Open-Drain Charge Status Output. When the battery is charging, the CHRG pin is pulled low by an internal N-channel MOSFET. When the charge cycle is completed, a weak pull-down of approximately 20µA is connected to the CHRG pin, indicating an “AC present” condition. When the XT4045 detects an undervoltage lockout condition, CHRG is forced high impedance.

GND (Pin 2): Ground.

BAT (Pin 3): Charge Current Output. Provides charge current to the battery and regulates the final float voltage to 4.15V. An internal precision resistor divider from this pin sets the float voltage which is disconnected in shutdown mode. When the battery reverse, the internal protection circuitry protect the chip will not be burned. And about 0.7mA current flows from GND to BAT.

VCC (Pin 4): Positive Input Supply Voltage. Provides power to the charger. VCC can range from 4.25V to 6.5V and should be bypassed with at least a 1µF capacitor. When VCC drops to within 100mV of the BAT pin voltage, the XT4045 enters shutdown mode, dropping IBAT to less than 2µA.

PROG (Pin 5): Charge Current Program, Charge Current Monitor and Shutdown Pin. The charge current is programmed by connecting a 1% resistor, R_{PROG} , to ground. When charging in constant-current mode, this pin serves to 1V. In all modes, the voltage on this pin can be used to measure the charge current using the following formula:

$$I_{BAT} = (V_{PROG}/R_{PROG}) \cdot 1000$$

The PROG pin can also be used to shut down the charger. Disconnecting the program resistor from ground allows a $3\mu A$ current to pull the PROG pin high. When it reaches the 1.21V shutdown threshold voltage, the charger enters shutdown mode, charging stops and the input supply current drops to $40\mu A$. This pin is also floated approximately 2.4V. Driving this pin to voltages beyond the floating voltage will draw currents as high as 1.5mA. Reconnecting PROG to ground will return the charger to normal operation.

■ Marking Rule

- SOT-23-5L、SOT-89-5L

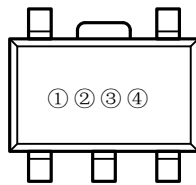

SOT-89-5L
(TOP VIEW)

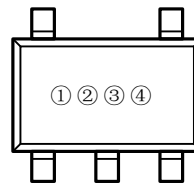

SOT-23-5L
(TOP VIEW)

- ① Represents the product name

Symbol	Product Name
7	XT4045◆◆◆◆◆

- ② Represents the type of the trickle charge voltage and CHRГ pin

Symbol	Product Series
K	XT4045K◆◆◆◆◆

- ③ Represents the regulator output voltage

Symbol	Voltage	Accuracy
B	4.15	±50mV

- ④ Represents the information about product quality tracking.

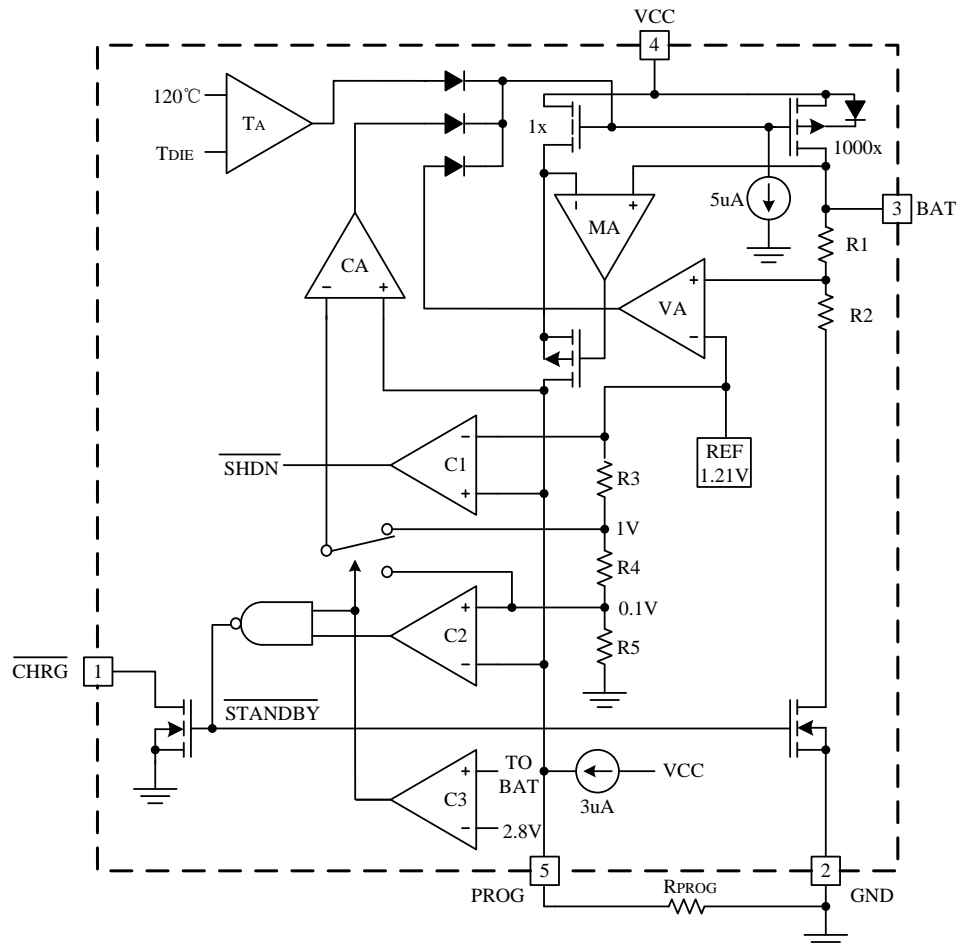
Block Diagram

Absolute Maximum Ratings

Parameter	Symbol	Maximum Rating		Unit
Input Supply Voltage	VCC	-0.3~12		V
PROG pin Voltage	Vprog	-0.3~VCC+0.3		
BAT pin Voltage	Vbat	-0.3~12		
CHAG pin Voltage	Vchrg	-0.3~+12		
Power Dissipation	P _D	SOT-23-5L	250	mW
		SOT-89-5L	500	
BAT pin Current	I _{bat}	500		mA
PROG pin Current	I _{prog}	800		uA
Operating Ambient Temperature	T _{opa}	-40~+85		°C
Storage Temperature	T _{str}	-65~+125		

Caution: The absolute maximum ratings are rated values exceeding which the product could suffer physical damage. These values must therefore not be exceeded under any conditions.

Electrical Characteristics

(TA=25°C unless otherwise noted)

Parameter	Symbol	Condition	Min	Typ	Max	Unit
Input supply voltage	VCC	-	4.25		6.5	V
Input supply current	Icc	Charge mode, Rprog=10K	-	200	400	μA
		Standby mode	-	100	200	μA
		Shutdown mode (Rprog not connected, VCC < Vbat or VCC < Vuv)	-	40	100	μA
Regulated Output Voltage	Vfloat	0°C < TA < 85°C, IBAT = 40mA	4.10	4.15	4.20	V
BAT pin Current	Ibat	Rprog=10k, Current mode	90	100	110	mA
		Rprog=2k, Current mode	450	500	550	mA
		Standby mode, Vbat=4.2V	0	-2.5	-6	μA
		Shutdown mode	-	1	2	μA
		Battery reverse mode, VBAT=-4V	-	0.7	-	mA
		Sleep mode, VCC=0V	-	1	2	μA
Trickle charge current	Itrikl	Vbat < Vtrikl, Rprog=2k	90	100	110	mA
Trickle charge Threshold Voltage	Vtrikl	Rprog=10K, Vbat Rising	2.7	2.8	2.9	V
Trickle voltage hysteresis voltage	Vtrhys	Rprog=10k	50	75	100	mV
VCC Undervoltage lockout Threshold	Vuv	From VCC low to high	3.7	3.8	3.93	V
VCC undervoltage lockout hysteresis	Vuvhys	-	80	100	120	mV
Manual shutdown threshold voltage	Vmsd	PROG pin rising	1.15	1.21	1.30	V
		PROG pin falling	0.9	1.0	1.1	V
VCC-Vbat Lockout Threshold voltage	Vasd	VCC from low to high	160	210	260	mV
		VCC from high to low	70	100	130	mV
C/10 Termination Current Threshold	Iterm/lc	Rprog=10k	0.085	0.10	0.115	mA/mA
		Rprog=2k	0.085	0.10	0.115	mA/mA
PROG pin Voltage	Vprog	Rprog=10k, Current mode	0.90	1.00	1.10	V
CHRG pin weak pull-down Current	Ichrg	Vchrg=5V	8	20	35	μA
CHRG pin Output low voltage	Vchrg	Ichrg=5mA	-	0.35	0.6	V
Recharge Battery threshold Voltage	ΔVrecg	VFLOAT - VRECHRG	50	100	150	mV

Typical Performance Characteristics

1. Charge Current VS Battery Voltage

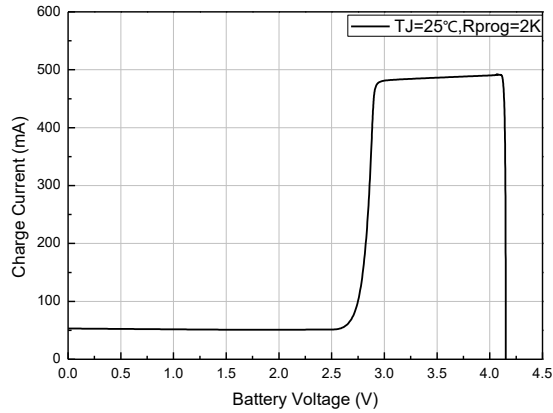

2. Charge Current VS PROG Pin Voltage

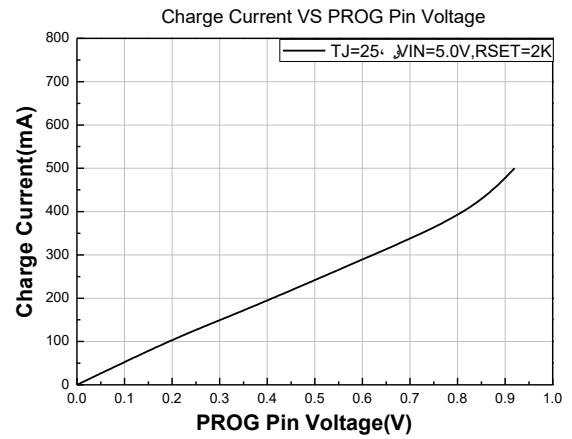

3. Charge Current VS Supply Voltage

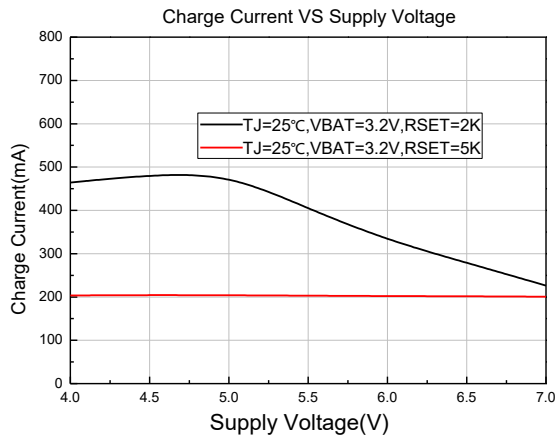

4. PROG Pin Pull-up Current VS PROG Pin Voltage

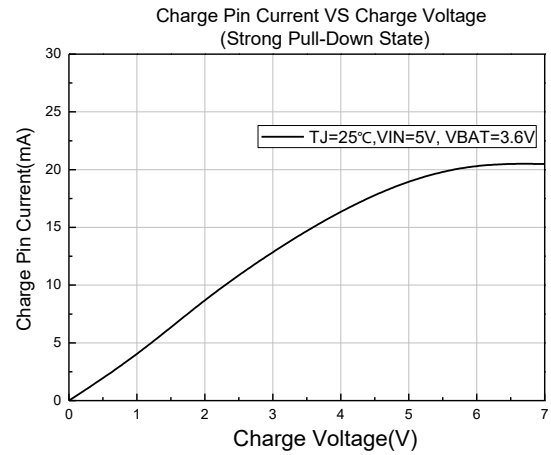

5. Charge Pin Current VS Charge Voltage (Weak Pull-Down State)

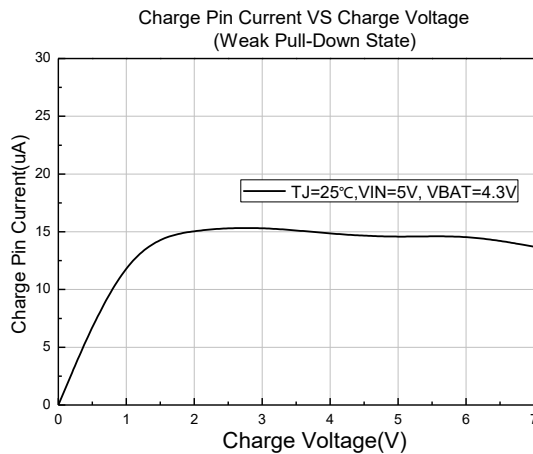

6. Charge Pin Current VS Charge Voltage (Strong Pull-Down State)

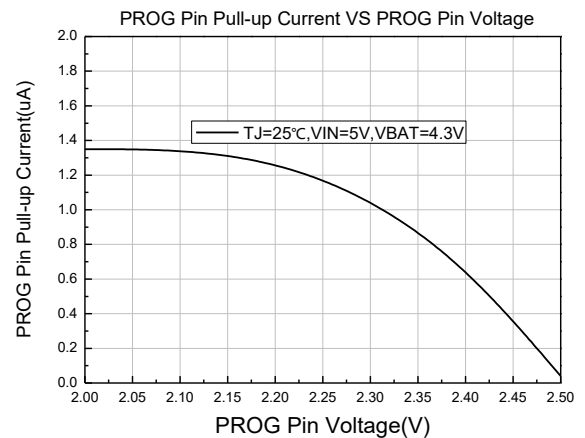

7. PROG Pin Voltage VS Supply Voltage

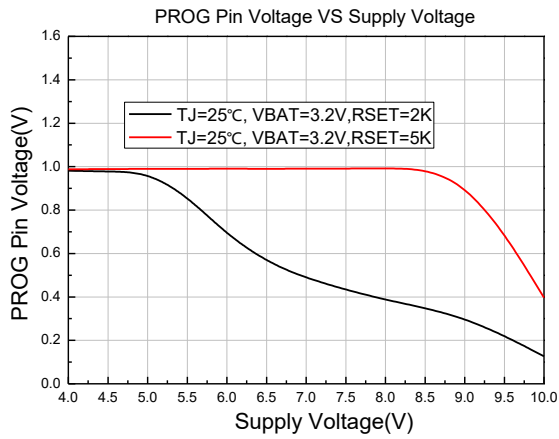

8. Trickle Charge Current VS Supply Voltage

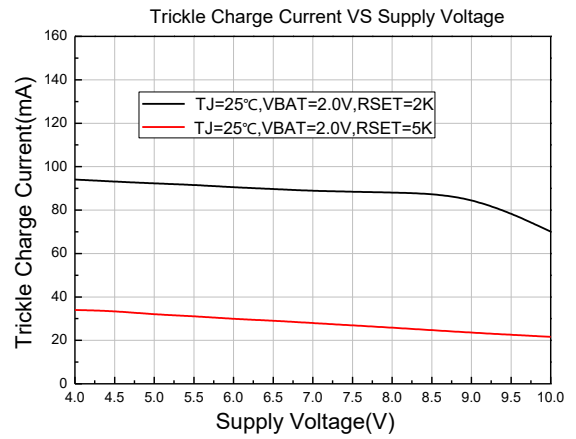

9. Regulated Output (Float) Voltage VS Supply Voltage

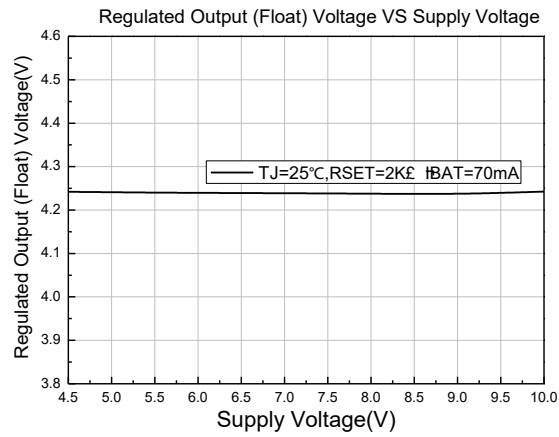

10. PROG Pin Voltage VS Temperature

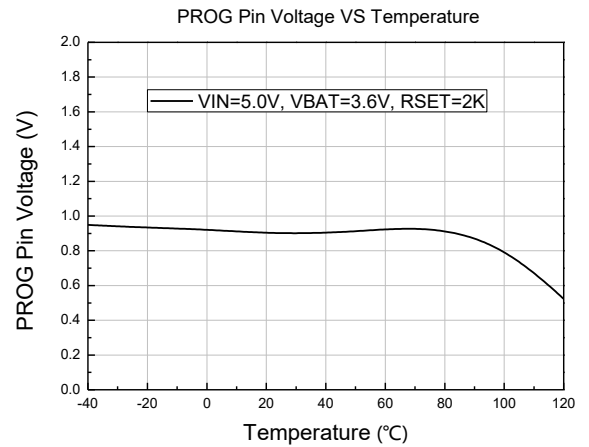

11. PROG Pin Pull-up Current VS Temperature

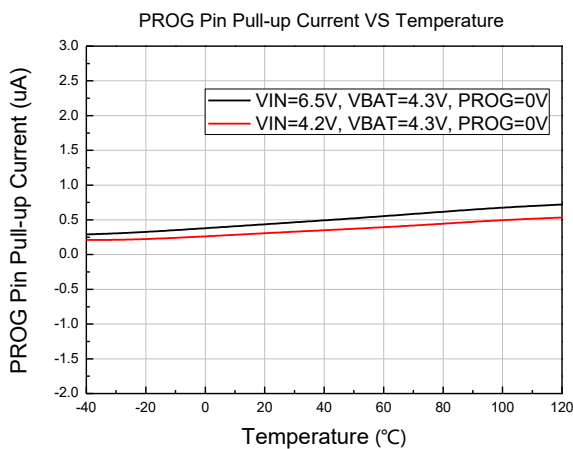

12. VBAT VS Temperature

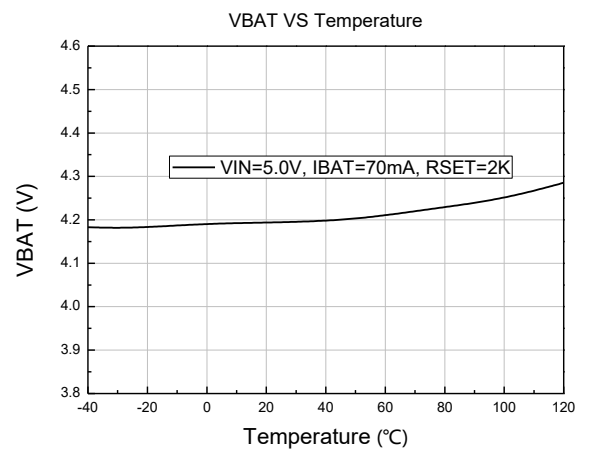

13. Recharge Battery threshold Voltage VS Temperature

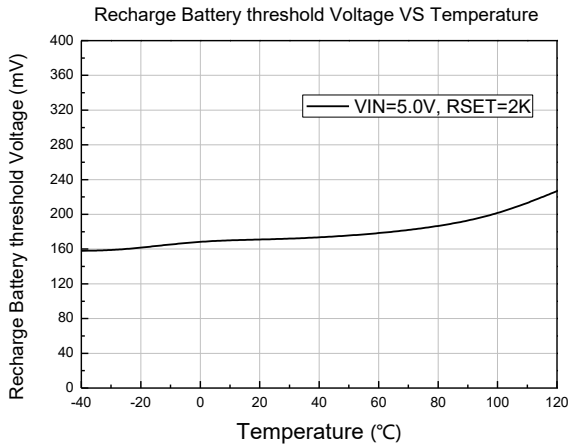

14. Charge Pin Current VS Temperature

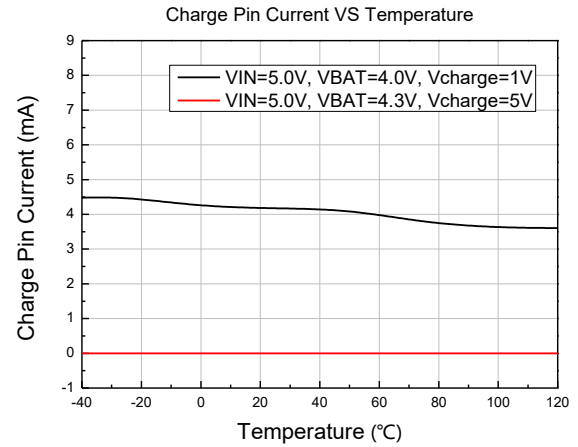

15. Trickle Charge Current VS Temperature

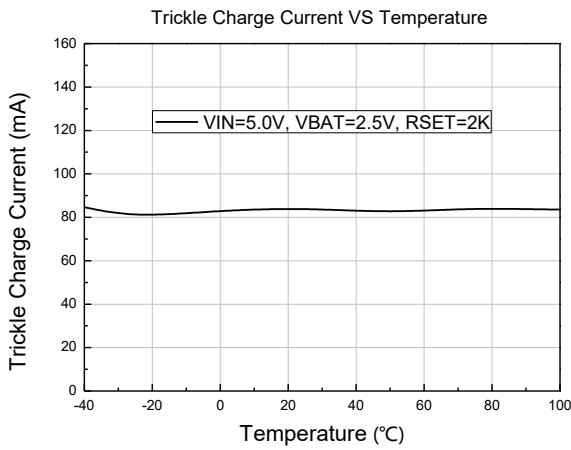

16. Trickle charge Threshold Voltage VS Temperature

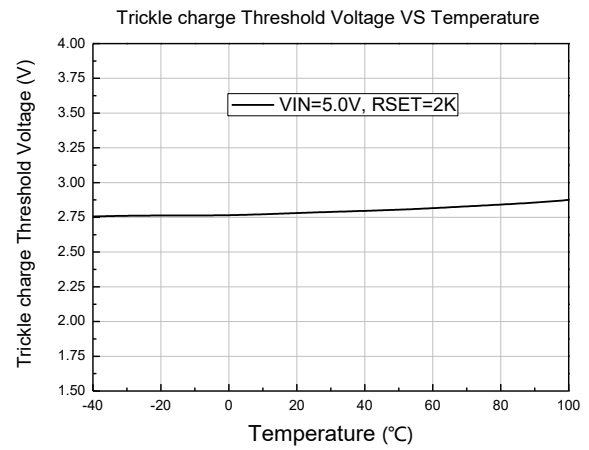

17. Charge Current VS Temperature

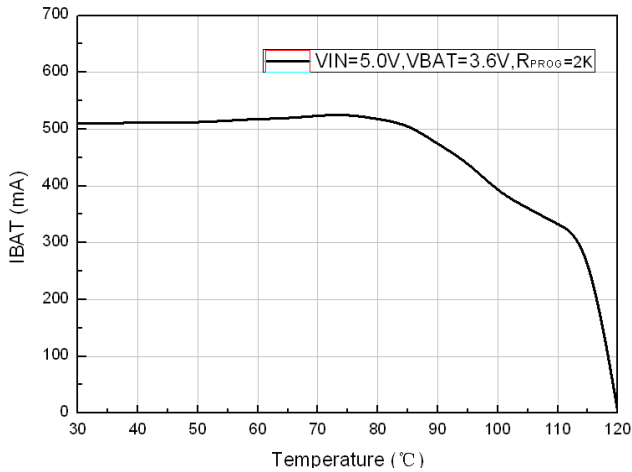

18. Power Tube Resistance VS Temperature

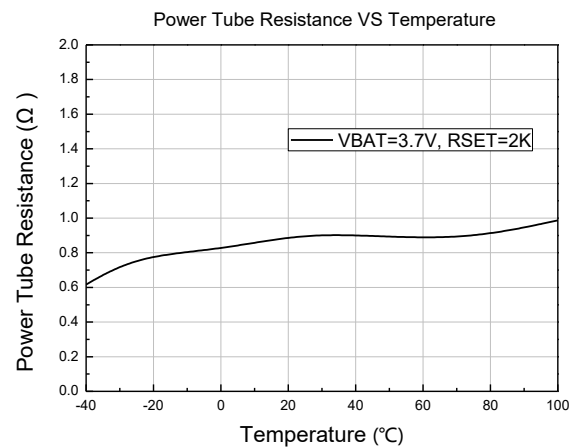

Package Information

- SOT-23-5L

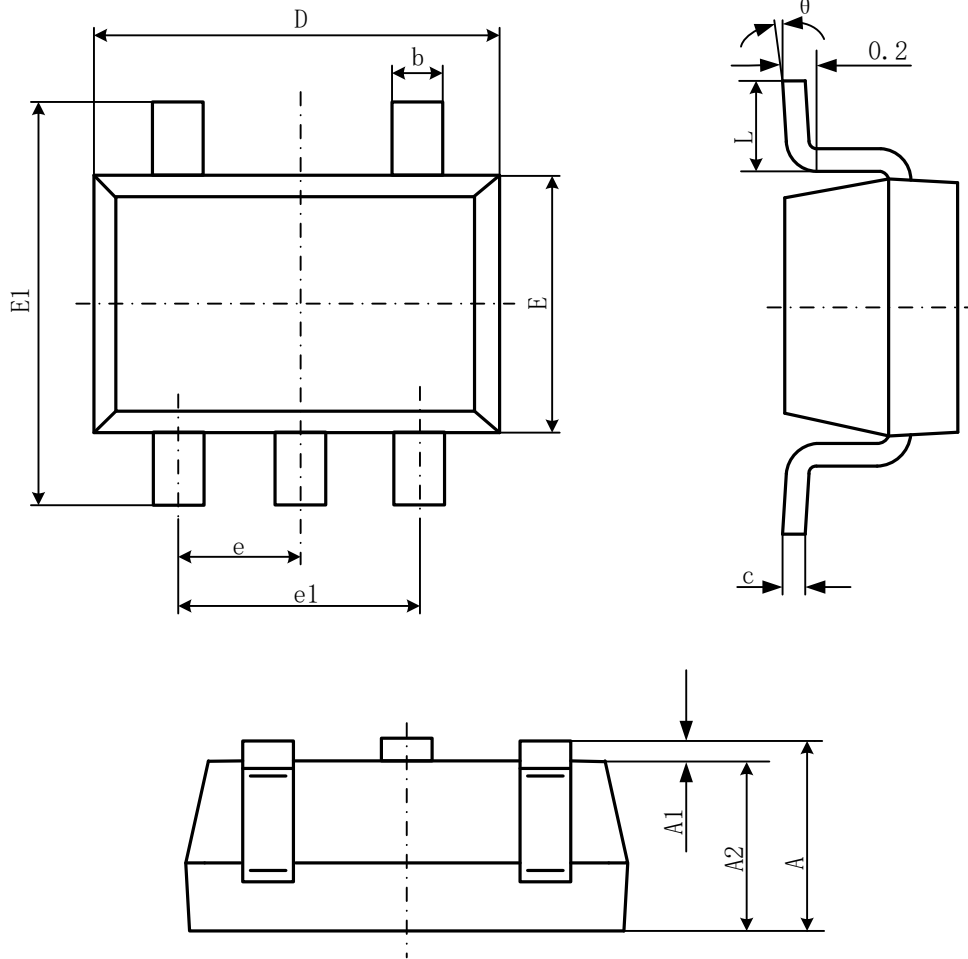

Symbol	Dimensions In Millimeters		Dimensions In Inches	
	Min	Max	Min	Max
A	1.050	1.250	0.041	0.049
A1	0.000	0.100	0.000	0.004
A2	1.050	1.150	0.041	0.045
b	0.300	0.500	0.012	0.020
c	0.100	0.200	0.004	0.008
D	2.820	3.020	0.111	0.119
E	1.500	1.700	0.059	0.067
E1	2.650	2.950	0.104	0.116
e	0.950(BSC)		0.037(BSC)	
e1	1.800	2.000	0.071	0.079
L	0.300	0.600	0.012	0.024
θ	0°	8°	0°	8°

● SOT-89-5L

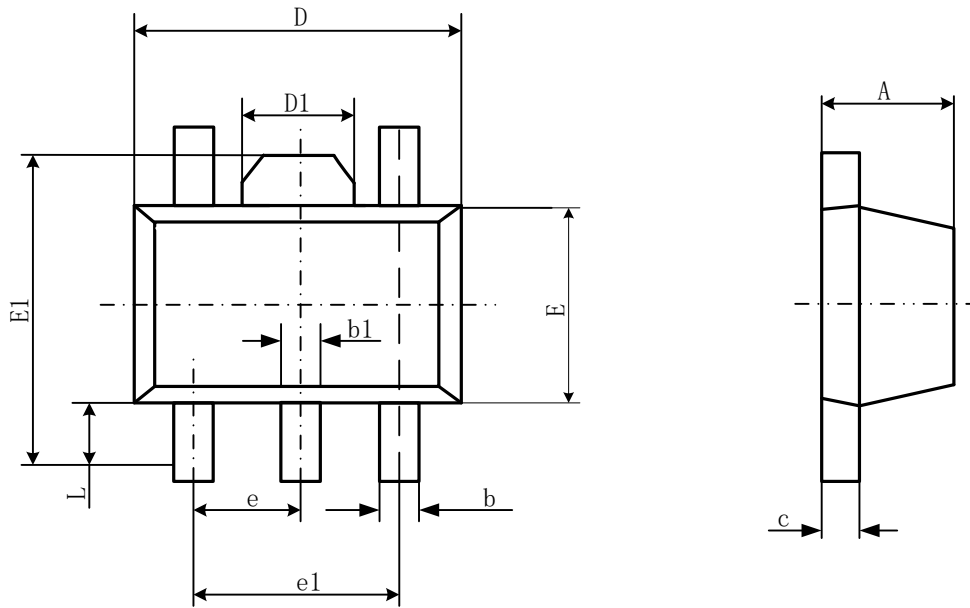

Symbol	Dimensions In Millimeters		Dimensions In Inches	
	Min	Max	Min	Max
A	1.400	1.600	0.055	0.063
b	0.320	0.520	0.013	0.020
b1	0.360	0.560	0.014	0.022
c	0.350	0.400	0.014	0.017
D	4.400	4.600	0.173	0.181
D1	1.400	1.800	0.055	0.071
E	2.300	2.600	0.091	0.102
E1	3.940	4.250	0.155	0.167
e	1.500TYP		0.060TYP	
e1	2.900	3.100	0.114	0.122
L	0.900	1.100	0.035	0.043